



**HIT FITNESS**







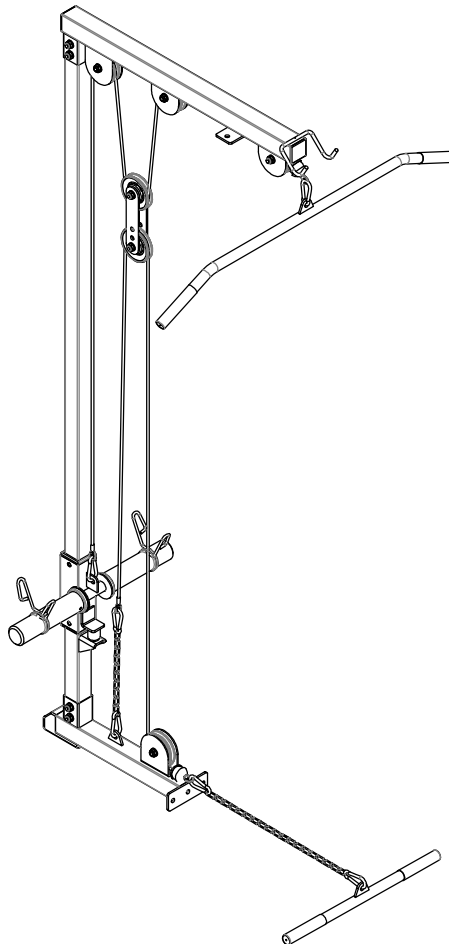

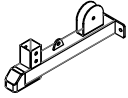
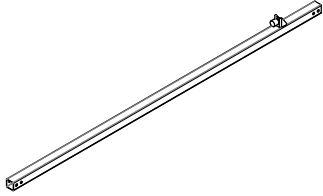
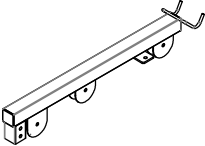
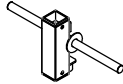

**HIT00769**

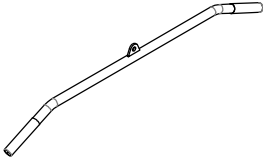
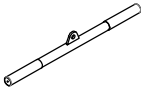
**Hit Fitness F100 Lat Pull / Low Pulley Row Attch**



**Assembly Manual**



## Component details

N0	Details drawing	count	N0	Details drawing	count
1		1	2		1
3		1	4		1
5		2	6		1
7		1	8	 (2,820mm)	2
9	 (Section 19)	1	10	 (Section 10)	1
11		6	12		2
13		2	14		2

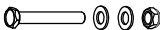
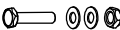
## Standard component

N0	Details drawing	count	N0	Details drawing	count
15	<b>M10 × 70 bolt,nut,washer</b> 	4	16	<b>M10 × 65 bolt,nut,washer</b> 	4
17	<b>M10 × 45 bolt,nut,washer</b> 	6	18	<b>gourd buckle</b> 	6

1

